

技术参数:

- 材料: 压铸铝
- 盖子材料: PC
- 表面处理: 粉末喷涂
- 颜色: RAL 7037 (灰色)
- 温度范围: -40℃ - +125℃
- 防护等级: IP65 (联锁状态, IEC 60529)
- 密封元件: NBR
- 出线方向: 侧出线
- 出线孔数: 2
- 螺纹规格: PG29

Technical specification:

- Material: aluminium die-cast
- Material,cover: PC
- Surface: powder-coated
- Colour: RAL 7037(grey)
- Temperature range: -40℃ - +125℃
- Degree of protection: IP65
(acc.to IEC 60529 for coupled connector)
- Hoods/Housings sealing: NBR
- Cable entry: side entry
- No. of cable entries: 2
- Thread size: PG29

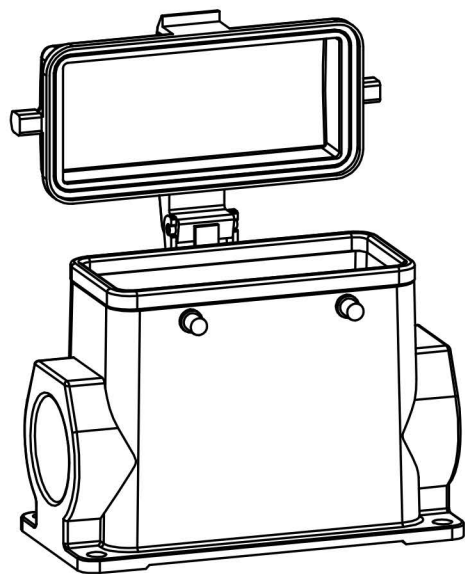

						表面处理 Finish	-			图号 Drawing No.	-
						材料 Material	-			产品代号 Part Code	H16B-SDRH-BO-2PG29
标记 Mark	次数 Number	变更描述/Description		姓名 Signature	日期 Date	比例 Scale	版本 REV.	重量 Weight	数量 Qty.	产品料号 Part No.	1490160229
绘图 Drawn		18.10.2010	标准化 Stand.	-	-	1:2	V1.0	437g	-	产品名称 Part Name	-
审核 Checked		18.10.2010									
工艺 Process	-	-	批准 Approved		18.10.2010			All Dimensions in mm Original Size DIN A 4		浙江西霸士电气有限公司	