

1

2

3

4

5

6

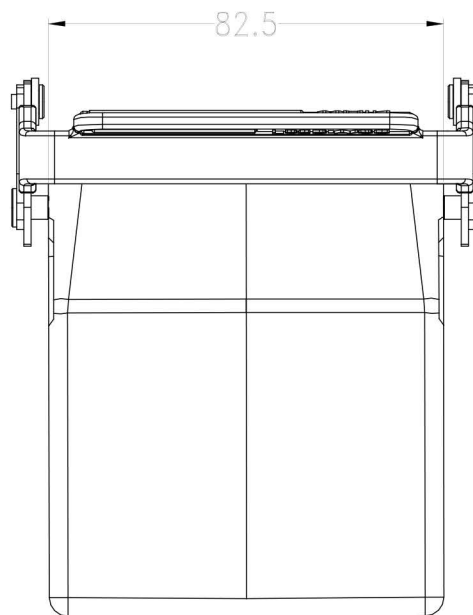
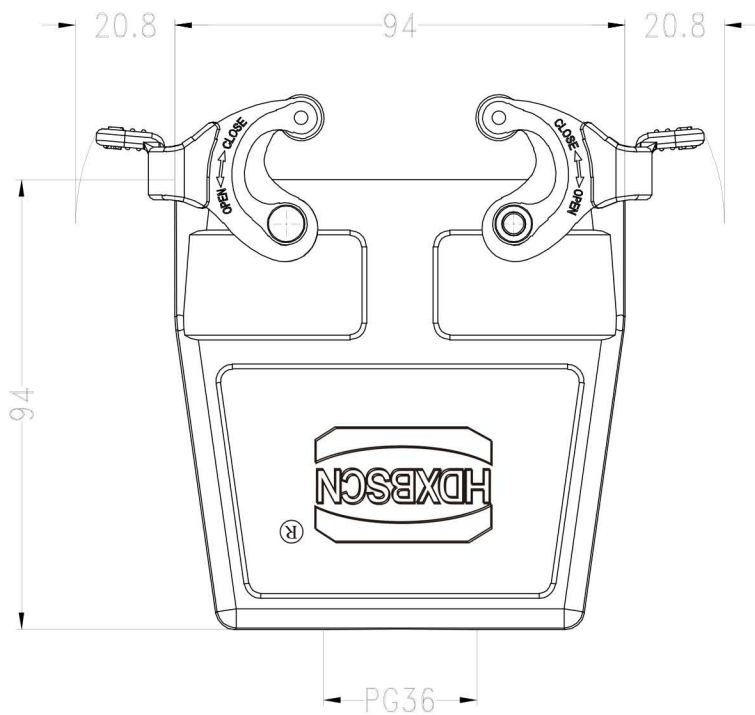

				表面处理 Surface				图号 Drawing No.	
				材料 Material				产品代号 Part Code	
标记 Mark		处数 Number		更改文件号/Changes File No.		签名 Signature		日期 Date	
		姓名/Name		日期/Date		姓名/Name		日期/Date	
绘图 Drawn				标准化 Stand.				比例 Scale	
审核 Checked								版本 RBV.	
工艺 Process				批准 Approved				重量 Weight	
								数量 Qty.	
								All Dimensions in mm Original Size DIN A 4	
								HDXBSCN 浙江西霸士电气有限公司	
								产品料号 Part No.	
								1710320136	
								产品名称 Part Name	