

技术参数:

- 材料: 压铸铝
- 盖子材料: PC
- 表面处理: 粉末喷涂
- 颜色: RAL 7037 (灰色)
- 温度范围: $-40^{\circ}\text{C} - +125^{\circ}\text{C}$
- 防护等级: IP65 (联锁状态, IEC 60529)
- 密封元件: NBR
- 出线方向: 侧出线
- 出线孔数: 1
- 螺纹规格: M25

Technical specification:

- Material: aluminium die-cast
- Material,cover: PC
- Surface: powder-coated
- Colour: RAL 7037(grey)
- Temperature range: $-40^{\circ}\text{C} - +125^{\circ}\text{C}$
- Degree of protection: IP65
(acc.to IEC 60529 for coupled connector)
- Hoods/Housings sealing: NBR
- Cable entry: side entry
- No. of cable entries: 1
- Thread size: M25

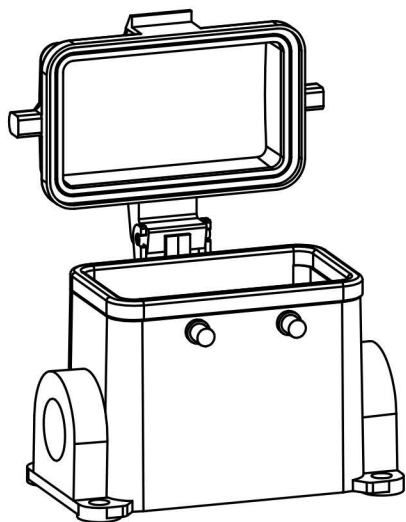

						表面处理 Finish		-		图号 Drawing No.	-
						材料 Material		-		产品代号 Part Code	H10B-SDR-BO-M25
标记 Mark	处数 Number	变更描述/Description		签名 Signature	日期 Date	比例 Scale		版本 REV.	重量 Weight	数量 Qty.	产品料号 Part No.
		姓名/Name	日期/Date	姓名/Name	日期/Date	1:2	V1.0	250g	-		1460100125
绘图 Drawn			18.10.2010	标准化 Stand.	-						产品名称 Part Name
审核 Checked			18.10.2010								-
工艺 Process				批准 Approved							
								All Dimensions in mm Original Size DIN A 4		浙江西霸士电气有限公司	